



www.barkbusters.net

FITTING INSTRUCTIONS for...

- YAMAHA XTZ700 Tenere ('25 on)
- YAMAHA XTZ700 Tenere World Raid ('26 on)

Preparation

Remove the original handguards (if fitted) and original bar end weights.

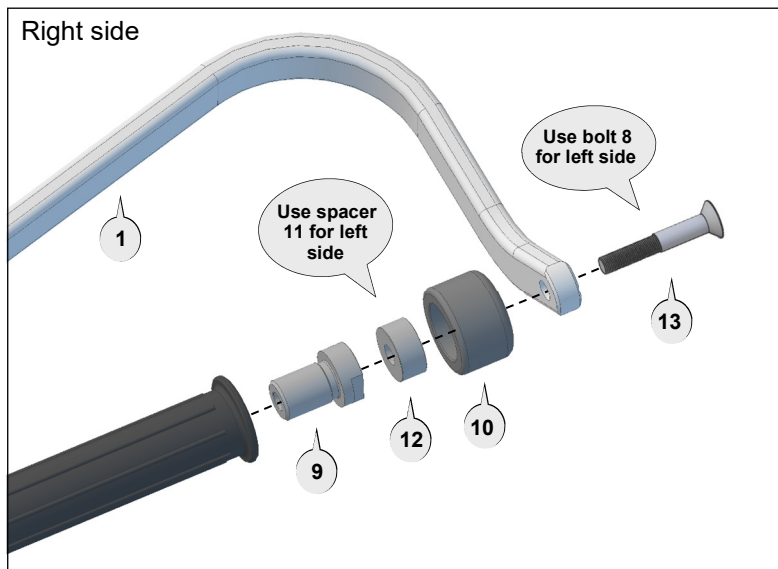
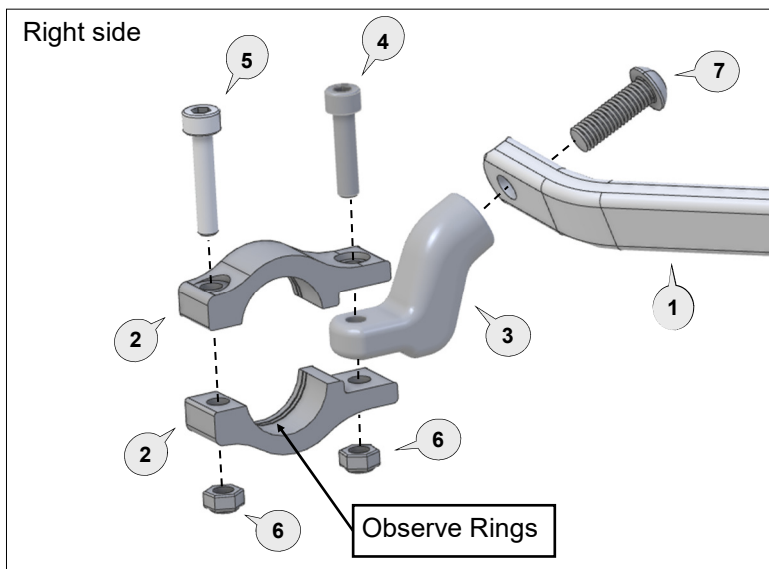

NOTE:

If heated grips are installed, may require 3mm of washers between bar-end weight and spacer, to ensure clearance between the weight and twist grip.

Bar Side View

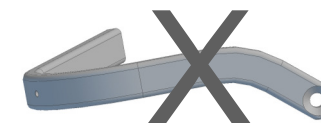
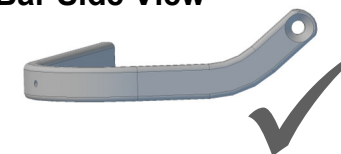

Fitting Procedure (make sure to use spacer (11) for the left side)

Important : There are rings machined into the inside of the tapered clamp surface to assist with a correct fit. The rings on both halves of the clamp should line up with each other and be positioned towards the centre of the motorcycle on the left and right side.

Loosely assemble clamp to handlebar as per diagram. Attach backbone with applicable parts to the handlebar and also to the clamp connector (3).

Note: Preferred backbone position is horizontal when viewed from side.
Tighten bolt (8) at the handlebar end.

Tighten Clamp bolts in the following order:

Tighten bolt (7) through the aluminium bar (1) or (2) to the clamp connector (3) of the clamp assembly.

Tighten bolt (4) to solidly lock the clamp connector (3) between the clamp saddles (2).

Tighten bolt (5) to secure the clamp assembly firmly to the handlebar.

Note: The clamp is designed to allow the nut (6) on bolt (4) to pull into the recessed hole. This eliminates the need for a wrench after the bolt starts to tighten.

Use recommended torque specifications over page.











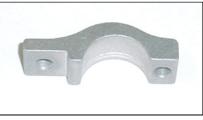

Personalise Your Protection

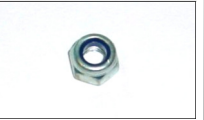
Guard options sold separately

JET	JET-003
VPS	VPS-003
Storm	STM-003
CARBON	BCF-003

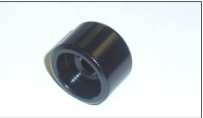

Phone: +61 (0)2 4271 8244
Email: info@barkbusters.net

<p>1 Aluminium Bar</p>  <p>PN: BAR-V067 Pcs. 1 Left & 1 Right</p>	<p>2 Clamp Saddle</p>  <p>PN: CS-02 Pcs. 2 Left & 2 Right</p>	<p>3 Clamp Connector</p>  <p>PN: CP5 Pcs. 2</p>	<p>4 Socket Head Bolt 25mm</p>  <p>PN: M6x25SHCSZP Pcs. 2</p>	<p>5 Socket Head Bolt 30mm</p>  <p>PN: M6x30SHCSZP Pcs. 2</p>	<p>6 Nylock Nut</p>  <p>PN: M6LN Pcs. 4</p>	<p>7 Button Head Bolt 25mm</p>  <p>PN: M8x25BHCSZP Pcs. 2</p>	<p>8 Flat Head Bolt 45mm</p>  <p>PN: M8x45FHCSZP Pcs. 1</p>								
<p>9 Treaded insert</p>  <p>PN: BESF2 Pcs. 2</p>	<p>10 Bar End Weight</p>  <p>PN: BEW-35 Pcs. 2</p>	<p>11 Spacer 5mm</p>  <p>PN: SP05-20-10 Pcs. 1</p>	<p>12 Spacer 10mm</p>  <p>PN: BSSRT10 Pcs. 1</p>	<p>13 Flat Head Bolt 50mm</p>  <p>PN: M8x50FHCSZP Pcs. 1</p>	<table border="1"> <thead> <tr> <th colspan="2">Recommended Torque Settings</th> </tr> </thead> <tbody> <tr> <td>M6</td> <td>10 Nm (7.4 lbf ft)</td> </tr> <tr> <td>M8</td> <td>28 Nm (20.7 lbf ft)</td> </tr> <tr> <td>M16 (item 9)</td> <td>40Nm (15.5 lbf ft)</td> </tr> </tbody> </table>			Recommended Torque Settings		M6	10 Nm (7.4 lbf ft)	M8	28 Nm (20.7 lbf ft)	M16 (item 9)	40Nm (15.5 lbf ft)
Recommended Torque Settings															
M6	10 Nm (7.4 lbf ft)														
M8	28 Nm (20.7 lbf ft)														
M16 (item 9)	40Nm (15.5 lbf ft)														

CAUTION:

Installation of the handguard is safety-relevant work and can be complicated. We recommend the installation be performed by a motorcycle service technician. Rideworx accepts no liability for damages caused by improper mounting. All screws, bolts and nuts, including all replacement hardware provided by Rideworx, should be tightened to the torque specified in the below table. After the first 50km of riding check all screws, bolts and nuts are tightened to the correct torque. We recommend a medium strength liquid thread lock product on all fasteners.

WARNING:

It is important there is a working clearance (approx 3mm) between the throttle grip end and the handguard to ensure a free closing throttle. Check operation of all handlebar controls, specifically the throttle, front brake, kill switch and clutch to ensure they are operating correctly and are in accordance with the OEM specifications. Do not ride the motorcycle if any controls are not operating correctly. Check periodically that all bolts are tight.



Phone: +61 (0)2 4271 8244
Email: info@barkbusters.net
Web: www.barkbusters.net



Disclaimer:

A failure to follow these fitting instructions could cause serious injury, death or property damage. These handguards are intended solely for use with motorcycles/ATV/snowmobiles/scooters that have not been modified. They are not designed to prevent injury or death while riding or in an accident or crash. The user must ensure that all controls are free of the handguards every time that they ride. By installing and/or using this product you acknowledge that you accept these terms and have followed the fitting instructions.